



## Numerical analysis of repaired wall loss defect pipelines for optimum composite wrap thickness

M. Khaisem S. Budhe

*National Institute of Technology Calicut, 673601, India*

*khaise.8088@yahoo.com, <http://orcid.org/0000-0003-0794-7494>*

*sandipiit@gmail.com, <http://orcid.org/0000-0002-3235-9232>*

S. de Barros

*CESI LINEACT, Saint-Nazaire, France*

*silvio.debarros@gmail.com, <http://orcid.org/0000-0002-2520-569X>*

M.D. Banea

*Federal Center of Technological Education (CEFET/RJ), Rio de Janeiro, 20271-110, Brazil*

*mdbanea@gmail.com, <http://orcid.org/0000-0002-8378-2292>*

N. R. F. Rohem

*Instituto Federal Fluminense, Rio de Janeiro, Brazil*

*neyrohem@gmail.com*

**ABSTRACT.** This paper presents the numerical analysis of failure pressure of wall loss defect metallic pipelines and validate it with experimental results. An optimization study is carried out using developed numerical model to propose the optimum composite repair thickness for cost effective repair system. A nonlinear explicit FE code with constitutive models for metallic steel and composite material to failure modelling was used. Three different cases: non-defective pipe, wall loss defective pipe and composite repaired of defective pipe are considered. It was found that the numerical results are in good agreement with the analytical results in all the three cases. Numerical results of composite repaired pipe were verified with hydrostatic test and both failure pressure and failure location closely matches, however the failure pressure determined by standard ISO/TS 24817 is too conservative for the same repair system. The optimization results revealed that even with reducing 40% of composite thickness with respect to the ISO/TS24817 standard, the repair system can sustain the designed failure pressure. The comparison showed that the standard ISO/TS 24817 provide an excessive composite repair thickness, which leads to increase the repair costs. Therefore, there is a scope for optimum composite repair thickness for cost effective repair system.



**Citation:** Khaisem, M., Budhe, S., de Barros, S., Banca, M. D., Rohem, N. R. F., Numerical analysis of repaired wall loss defect pipelines for optimum composite wrap thickness, *Frattura ed Integrità Strutturale*, 63 (2023) 153-168.

**Received:** 24.07.2022

**Accepted:** 14.10.2022

**Online first:** 17.11.2022

**Published:** 01.01.2023

**Copyright:** © 2023 This is an open access article under the terms of the CC-BY 4.0, which permits unrestricted use, distribution, and reproduction in any medium, provided the original author and source are credited.



**KEYWORDS.** Composite Repair, Numerical modelling, Optimization, Composite thickness, Wall loss defect, Corroded pipeline.

## INTRODUCTION

**M**etallic pipelines are the most economical and safest way to transport fluids over a long distance. In general, pipelines are made of steel due to its high strength and cost compared to other metals. However, steel tend to degrade in corrosive environment, in addition to that the pipe is subjected to many factors during its service period, which ultimately cause degradation with time. During inspections and maintenance, engineers frequently deal with the problem of pipe wall metal loss [1]. If the external wall loss defect is in unacceptable condition there is a need to go for repair/replace the defect pipe. In recent decades, composite wrap over the defected region is gain momentum due to its technical and economic advantages and now widely used instead of steel sleeved for repairs.

Design and repair standard such as ISO/TS 24817 and ASME-PCC 2 are well developed and define the complete procedure for composite repair of metallic pipe and they are widely accepted in pipeline renovation/repair [2, 3]. These standard methods are in practices for composite repair of damaged pipeline for both wall loss and through wall defect in all sectors. In regard to the design code, researchers performed hydrostatic test as per standards for the assessment of different composite materials, geometrical parameters, etc [4-8]. The research focuses on improving the existing methodology/procedure of ISO/TS 24817 and ASME-PCC2 design code for qualification of composite materials, putty materials and geometrical parameter of composite repair wrap.

Several studies have been conducted analytically and experimentally to understand the behavior of the repaired pipeline with the Fibre Reinforced Polymer (FRP) composite and optimize the composite material and geometrical parameters for better performance [9-15]. Hydrostatic burst tests are generally recommended for assessing the performance of composite repair of metallic pipes. ASME PCC-2 [2] and ISO/TS 24817 [3] composite repair standards were developed to provide the guidelines for designing a reliable repair, which guarantees the structural integrity. Still, there is a continuous modification of the standard over the material characterization and designing equations with the input from the research studies.

Recently, several authors are working on numerical modelling of composite repair of damaged pipeline on various aspects and reported that there is scope for modification of design standard for cost effective repair process [5, 15-19]. Composite repair thickness is one of the important parameters in pipe repair operation, which plays significant role in terms of repair strength and repair cost. In addition to composite thickness, putty material (filler material), defect geometry, configuration of composite wrap and loading condition plays a significant role over the performance of composite repair system [20-28]. These parameters need to be investigated in details for better understanding of the behavior of composite-repaired steel pipelines and subsequently improve the performance of composite repair systems. Researchers found that the prediction of composite repair thickness as per ISO/TS 24817 standards is too conservative compared with the numerical and hydrostatic test results [5, 12, 16, 17, 29, 30]. For example, Saeed et al. [12] reported the calculated composite repair thickness using ASME PCC-2 standards is 4.57 mm and using numerical analysis it is 3.1 mm for the same designed pressure. Similar trend reported by some other researchers and in some cases, the calculated composite repair thickness using ISO/TS 24817 and ASME PCC-2 is almost two-to-three times more than the numerical results obtained for the same configuration of the pipe-composite system and for same design pressure [5, 12, 31]. Possible reason for overpredicting the composite repair thickness is the neglecting the maximum capacity of pipe material. However, the conservative composite repair thickness can ensure safe design for the long-term performance of the composite repair. An increased thickness of the wrap could prevent yielding of the pipe at the defect section as well as enhance the strength of the pipe in the axial direction, but does not guarantee regarding the plastic deformation of the pipe far away from the defect region [32, 33]. Patch repair process can be alternate to the complete composite wrap repair technology for the small size and shallow defect size. Theisen and Keller [34] conducted numerical and experimental tests for both patch and wrap repairs on through-wall defects and they reported the maximum strain of patch is higher than with composite wrap type system [34]. Ayaz et al. [35] showed that the increment in overlap length could enhance the failure strength in composite patch repair system for a through wall defect. This indicate, the FRP patch repair system can be a good choice for small-area though wall defect and wall loss defect.

ISO/TS 24817 and ASME PCC-2 design code predicted a very conservative repair thickness and the only difference between the two codes is the definition of allowable stress ( $\sigma$ ), as per ASME PCC-2 it is specific minimum yield stress and the pipe allowable stress in case of the ISO/TS24817 standard.

The equation to determine the composite repair thickness using both the code is given as [12]:



$$\epsilon_C = \frac{PD_{ext}}{2E_c t_{min}} - s \frac{t_s}{E_c t_{min}} - \frac{P_{live} D_{ext}}{2(E_c t_{min} + E_s t_s)} \tag{1}$$

Eq. (1),  $P_{live}$  is the internal pressure in the pipe at the time of repair application,  $E_c$  and  $E_s$  are composite and steel module of elasticity,  $t_s$  is remained pipe wall thickness,  $t_{min}$  is minimum required thickness of composite layer,  $D_{ext}$  is pipe diameter,  $P$  is design pressure and finally  $\epsilon_C$  is the composite allowable strain. The above equation as per standard ISO/TS 24817 and ASME PCC-2 gives a conservative repair thickness, hence it is safer and can sustain higher pressure but it requires more composite materials which incur more repair cost. It is very important to analyse the optimum composite repair thickness for cost effective repair system using numerical and analytical method and it should be validated with the experiment data set for assurance.

The primary objective of this study is to develop 3D FE numerical model to evaluate the mechanical behavior of the wall loss defect pipeline and validate with glass fiber reinforced polymer (GFRP) composite repair systems. The numerical results of composite repair thickness are validated with previous experimental results of repaired wall loss defect pipe. The optimization of composite wrap thickness is performed on wall loss defect metallic pipeline for safe and economical composite repair system using numerical model. The proposed numerical model in this research can be used to optimize the composite repair thickness for cost effective repair system.

## MATERIALS AND METHOD

### Materials

Hydrostatic test was performed on composite repair of API-5L X56 steel pipe with 80% wall loss defect and the properties of the polymeric composite material was also determined before used for the damaged pipe. The steel pipe material has the following basic properties: Young’s modulus =210 GPa and yield stress=386 MPa and ultimate tensile stress =625 MPa. Tab. 1 presents the material properties of glass fibre and epoxy resin which used for wrap lamination over defect region of pipe. The experimental results of hydrostatic test and property determination of new polymeric composite material was already published in a previous study [4]. However, further a brief summary of the results is presented.

Material	Density (g/cm <sup>3</sup> )	Young’s modulus (GPa)	Poisson’s ration	Tensile strength (MPa)
Fiber glass	2.55	72	0.21	3300
Epoxy resin	1.18	3.5	0.30	72

Table 1: Material properties used for manual lamination.

### Pipe Testing

Tab. 2 presents the geometrical dimension of wall loss defect API 5L X56 steel pipe. The length of pipe specimen is 600 mm and repaired length 300 mm which is half of the pipe length. Composite wrap (glass fibre reinforced) of 16.2 mm thickness calculated based on the design code ISO/TS 24817 is applied over defect region of pipe. Repaired wall loss defect pipeline is as shown in fig. 1. A well detailed hydrostatic test procedure and parameters are explained in [4]. The pressure curve of the hydrostatic test for repaired pipe is presented in Fig. 2. The repaired pipe with 16.2 mm composite thickness sustained the original design pressure of 32.3 MPa.

Parameters	Dimensions (mm)
Pipe thickness (t)	7.11
External diameter ( $D_{ext}$ )	168.3
Defect length (L)	86.82
Defect Width (W)	39.1
Depth of defect (d)	5.65

Table 2: Geometrical parameter of metallic pipe and defect geometry [4].



Figure 1: Repaired wall loss defect pipeline specimen for Hydrostatic test.

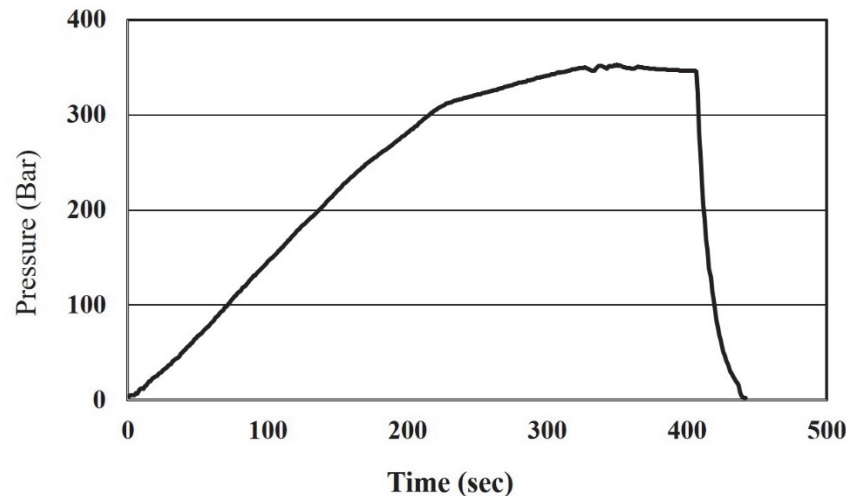

Figure 2: Pressure curve of hydrostatic test of repaired pipeline.

### Finite Element Analysis

Numerical analysis of composite repair of wall loss defect metallic pipeline is carried out using ABAQUS v6 finite element software package to simulate three cases: solid pipe, pipe with wall loss defect and composite repair of defected pipe. Fig. 3 shows the CAD model of solid pipe and wall loss defect pipe and the modelling part has been done in CATIA V5.

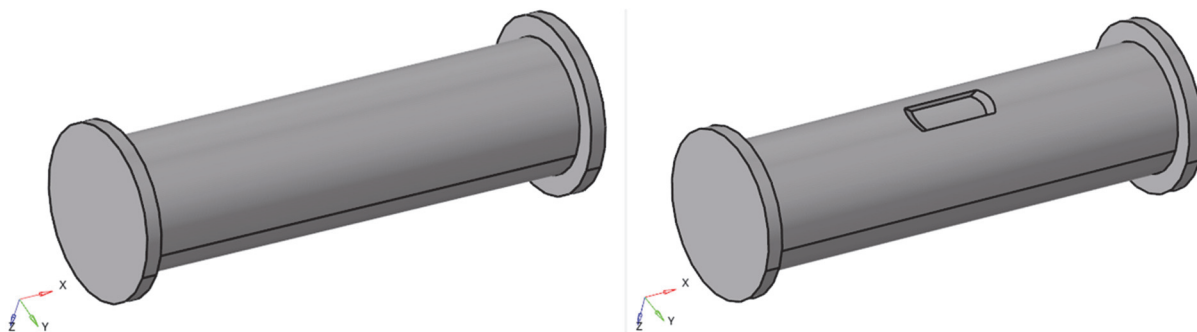

Figure 3: CAD image of pipe (a) without defect (b) with defect

Total number of nodes for the system is too high and to solve such system will take a long time, so a quarter model with symmetric boundary condition to reduce the computational time was considered (see Fig. 4).

The steel pipe was modelled (elastic-plastic) based on the test data acquired from tensile test of steel pipe with yield stress of 386 MPa using solid 3D stress linear element. The putty material (filler) is used to fill the defect cavity with epoxy resin and modelled using solid 3D stress linear element. The behavior of filler material was described by an elastic-plastic material model.

The mesh size effect on results has been validated using mesh size convergence. The mesh size used in the analysis is 2.8mm at the critical areas. The results were validated with a very fine mesh size of 0.82 mm and the deviation observed was 3% (see Fig. 5). The number of nodes and elements of each case is shown in Tab. 3.

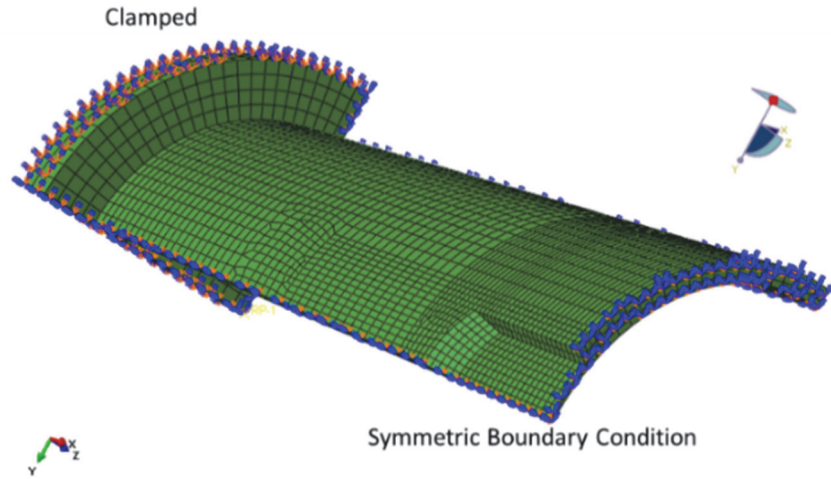

Figure 4: FE mesh model with boundary conditions.



Figure 5: Finite element model with fine mesh of 0.82 mm element size.

Sr. No.	Model	Number of nodes	Number of elements
1	Pipe without defect	7165	4944
2	Pipe with defect	9508	6640
3	Repaired pipe with composite wrap	9852	8449

Table 3: Number of nodes and elements.

The composite laminate is modelled using 2D axisymmetric shell element. The composite failure and damage modelling was done using Hashin damage criterion. The Hashin's failure criterion is used to evaluate failure in an individual composite ply [16]. This predicts the damage modes such as fiber failure in tension and compression, and matrix cracking in tension and compression.

The fiber failure index is defined as follows:

If  $\sigma_{11} \geq 0$  then the tensile fiber failure criteria is

$$F_f F_{f^+} = \left( \frac{\sigma_{11}}{S_{11+}} \right)^2 + \alpha \left( \frac{\sigma_{11}}{S_{12}} \right)^2 \geq 1.0 \quad (2)$$

If  $\sigma_{11} < 0$  then the compressive fiber failure criteria is



$$F_f = \left( \frac{\sigma_{11}}{S_{11-}} \right)^2 \geq 1.0 \tag{3}$$

If  $\sigma_{11} \geq 0$  then the tensile matrix failure criteria is

$$F_m F_{m^+} = \left( \frac{\sigma_{22}}{S_{22+}} \right)^2 + \alpha \left( \frac{\sigma_{12}}{S_{12}} \right)^2 \geq 1.0 \tag{4}$$

If  $\sigma_{11} < 0$  then the compressive fiber failure criteria is

$$F_m = \left( \frac{\sigma_{22}}{2S_{23}} \right)^2 + \left[ \left( \frac{s_{22-}}{2S_{23}} \right)^2 - 1 \right] \left( \frac{\sigma_{22}}{S_{22-}} \right) + \left( \frac{\sigma_{12}}{S_{12}} \right)^2 \geq 1.0 \tag{5}$$

Concept of inflated pressure cavity has been considered to simulate the behavior of pipe with pressure changes and assure the application of uniform pressure. The pressure load was applied to the internal surface of the tube. The pressure load for all models started from internal pressure  $P_i$  and gradually increased to the higher pressure. The interface between the steel pipe and repair laminate for model is assumed to be perfect bond using tie constraint.

## RESULTS AND DISCUSSIONS

Numerical analysis is carried out for three cases: solid pipe without defect, pipe with defect and composite repair of wall loss defect pipe. Results of all three cases are discussed and compared with analytical failure pressure. In addition to that, an experimental failure pressure of composite repair of wall loss defect pipe is compared with the numerical modelling results. Lastly, an optimisation of composite repair thickness is carried out using numerical modelling.

### *Pipe without defect*

Analytical failure pressure of pipe without defect is calculated based on the yield criterion and the analytical formula is given as:

$$P_f = \frac{(2.t.S_a)}{D_{ext}} \tag{6}$$

where,  $t$  is the pipe thickness and  $D_{ext}$  is the external diameter of pipe and  $S_a$  is the allowable stress of pipe.

The maximum sustained failure pressure of pipe can be determined from the above simple equation with considering the maximum yield strength of pipe as an allowable stress. The maximum failure pressure obtained ( $S_a = \sigma_y = 386 \text{ MPa}$ ) from analytical formula is 32.61 MPa for the steel API-5L X56 pipe thickness of 7.11 mm and diameter of 168.3 mm (Tab. 2). The failure pressure obtained from numerical model is 34.6 MPa for the same configuration. It is clearly noticed (Tab. 4) that the numerical results are closely match with the analytical failure pressure with an acceptable error limit of 6%. The result of numerical analysis of von Mises stress of steel pipe without defect is shown in Fig. 6 and it shows that the pipe is experiencing a maximum 386 MPa stress for failure pressure of 34.6 MPa. Fig. 7 shows the true stress-strain and Ramberg-Osgood stress-strain curve of API 5L X56 Steel.

The design pressure of the pipe which is obviously the lower than the failure pressure and it can be calculated with the allowable limit by keeping the 28% margin:

$$P_d = \frac{(0.72.t.S_a)}{r} \tag{7}$$



	Analytical (MPa)	Numerical (MPa)	Numerical- Analytical difference (%)
Failure pressure, $P_f$	32.61	34.6	6%

Table 4: Comparison of failure pressure between analytical and numerical analysis.

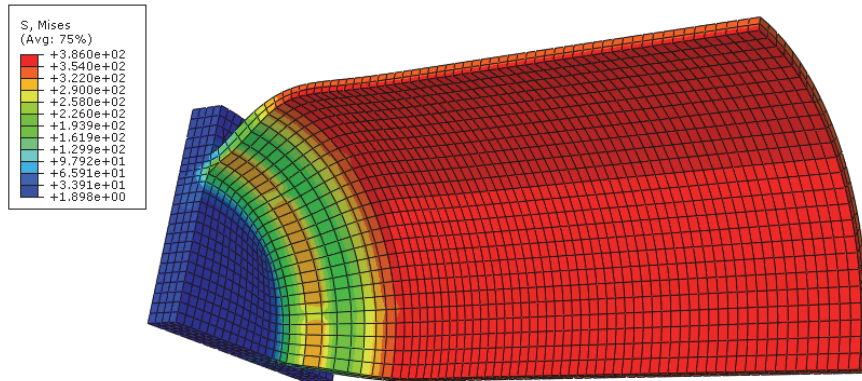

Figure 6: von Mises stress of steel pipe without defect.

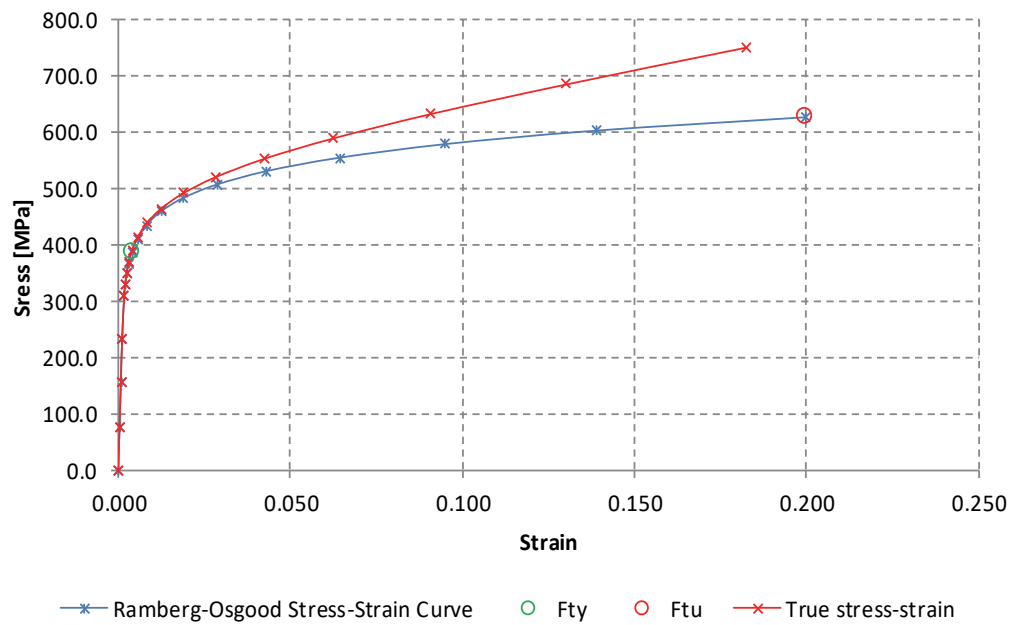

Figure 7: Stress-Strain curve of steel pipe.

### Pipe with defect

The pipe used in the hydrostatic test is machined 80 % wall loss thickness (5.65) with defect area of 39.11 (width)/56.2 (length). The same defect area is considered for the numerical analysis and the maximum failure pressure obtained is 6.21 MPa by keeping the pipe yield as a limiting parameter. From Tab. 5, it can be observed that both numerical and analytical failure pressure are in close agreement. Fig. 8 shows the maximum von Mises stress developed on steel pipe with wall loss defect is 386 MPa for failure pressure of 6.21 MPa.

	Analytical (MPa)	Numerical (MPa)	Numerical- Analytical difference (%)
Failure pressure, $P_f$	6.69	6.21	7.0%

Table 5: Comparison of pressure between analytical and numerical analysis for defected pipe.

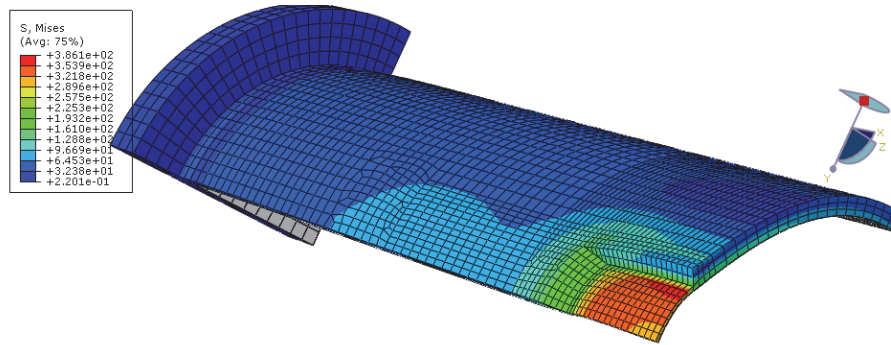

Figure 8: von Mises stress develop on steel pipe with 80% wall loss defect.

*Repaired pipe with composite wrap*

Experiment (hydrostatic test) was performed on the 80% wall loss defect pipe repaired using glass-fibre reinforce composite wrap. Composite wrap consists of 54 layers and each layer of 0.3 mm thickness, which account the total repair thickness of 16.2 mm as per ISO/TS 24817 design standard. A bidirectional fabric of glass fibers oriented at 0° in its longitudinal direction and 90° to the transverse direction was used. The same dimensions and configuration are maintained in the numerical analysis as that used in hydrostatic pipe test. Fig. 9 shows the mesh model of repair components such as glass woven fibres, resins (epoxy), wall loss defect pipe and the assembled repaired wall loss defect pipeline.

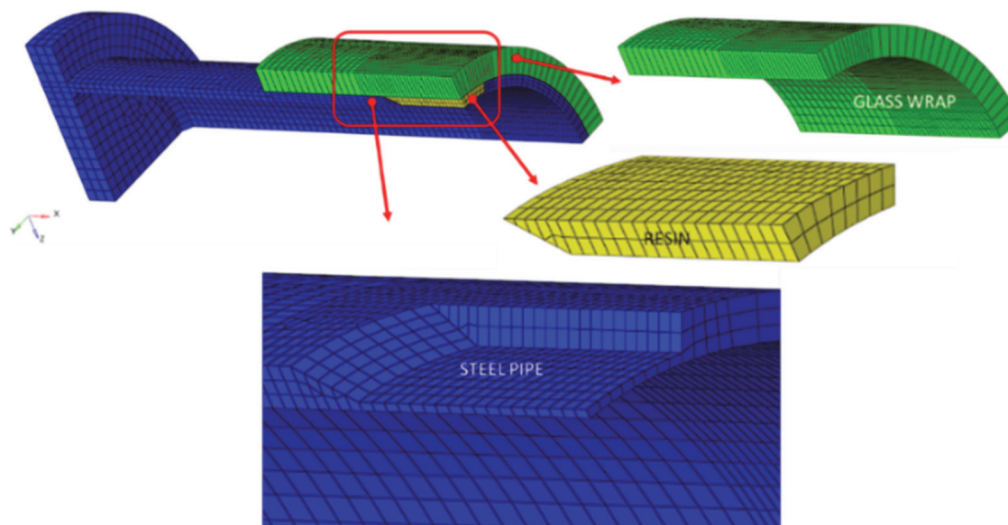

Figure 9: FE Model of Composite Wrap

The failure pressure was recorded as 36.28 MPa as shown in Tab. 6 for the repaired pipe during hydrostatic test. The failure pressure of 34 MPa was found by numerical analysis, which is little closer to the experimental failure pressure. Neglecting plastic deformation (strain hardening) in theoretical analysis of ISO/TS 24817 and other parameters such as damage factor and material properties are the possible reason for the deviation in failure pressure between numerical and experimental results [7]. However, the calculated analytical failure pressure using standard ISO/TS 24817 code is conservative compared to the numerical and experimental results. Yield stress of pipe is considered as the maximum limit (allowable stress) in the steel metallic pipeline in analytical model however plastic deformation occur during the numerical analysis and this is one of the possible reasons for the deviation of failure pressure between analytical and numerical.

	Analytical (MPa)	Numerical (MPa)	Experiment (MPa)
Failure pressure, $P_f$	32.3	34	36.28

Table 6: Comparison of failure pressure between analytical, numerical and experimental analysis.



Fig. 10 shows the failure margin of +0.67 (1-0.33) using Hashin failure criteria. The observed hoop and axial stress of 144 MPa and 22 MPa respectively are in the allowable range (Fig. 11). This indicate the composite wrap sustain the internal design pressure without any failure occur in the composite wrap at defect section. Fig. 12 shows the hoop and axial stress at the particular time instant. The pressure load has applied in amplitude 25% in 0.25 sec and 50% in 0.5 sec respectively to 100%.

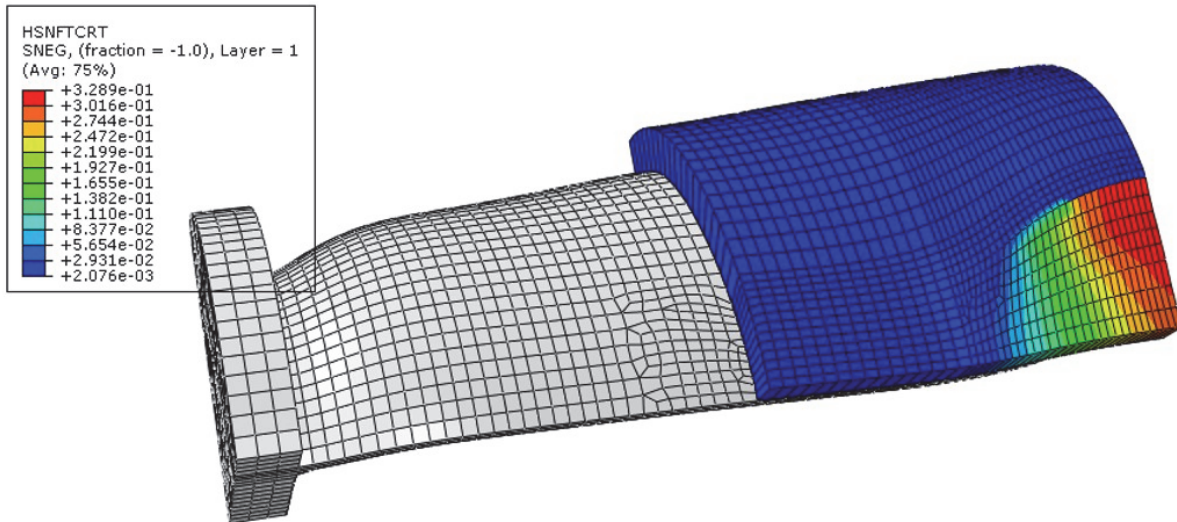

Figure 10: Failure index using Hashin failure criteria with 34 MPa pressure.

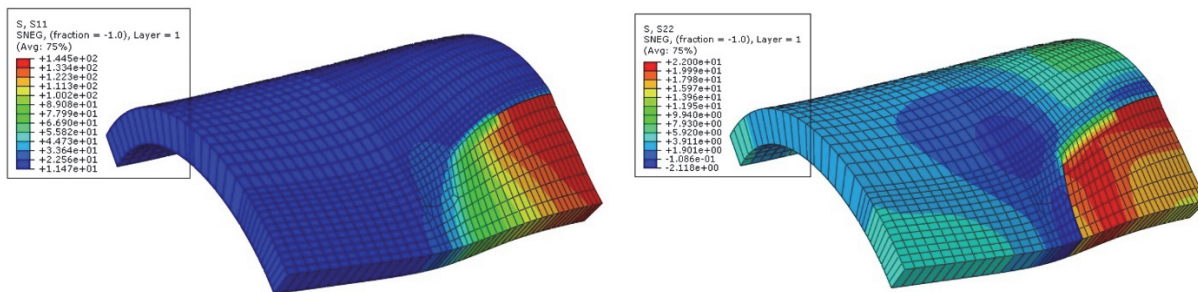

Figure 11: Hoop Stress 144 MPa & Axial Stress 22 MPa developed on composite wrap.

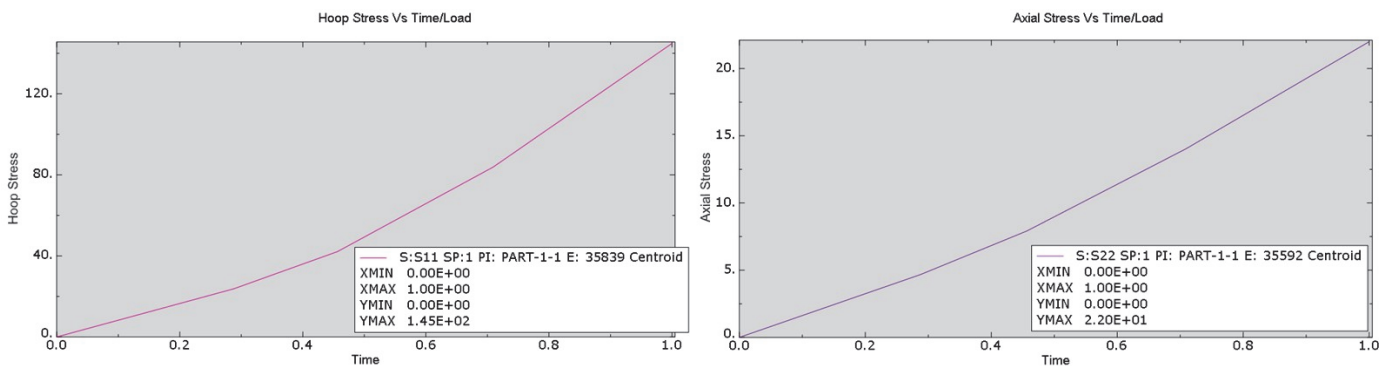
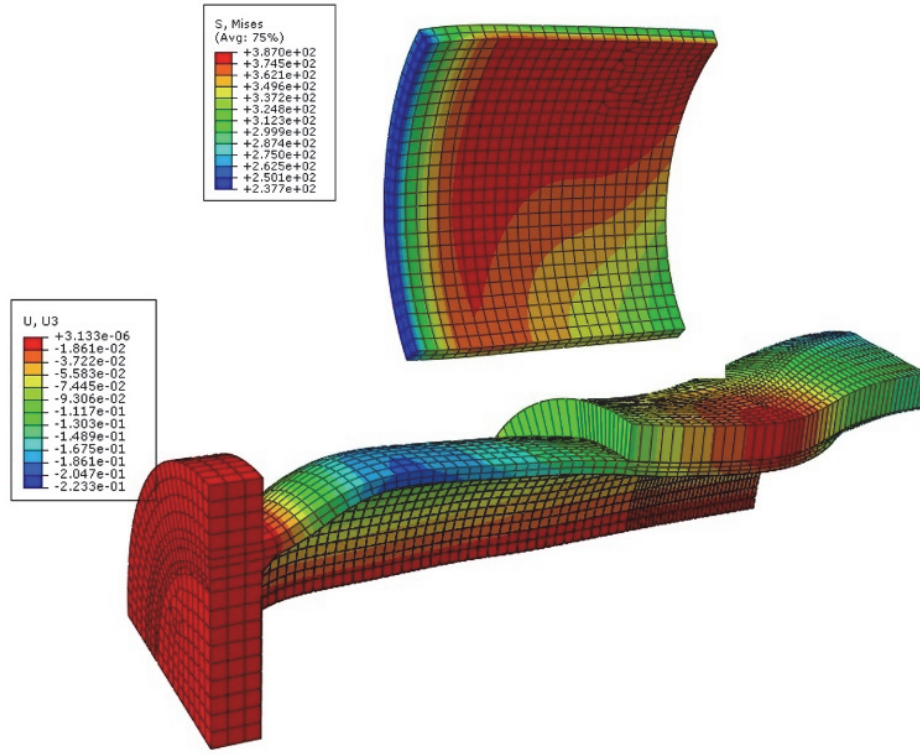

Figure 12: Hoop Stress (S11) and Axial Stress (S22) based on material orientation of composites.

Fig. 13a shows the deformation of pipe occurred quite away from the defect region which is near to the end of the pipe. On the same location failure occurred from hydrostatic test of repaired pipe of 80% wall loss defect (see Fig. 13b). On magnifying the image (Fig. 13b), it is clearly seen that the plastic deformation of the tube occurred instead of failure of the composite repair [11]. Hence, the pipe repaired with the given composite repair thickness can sustain the designed pressure without failure of the composite repair pipe. Mazurkiewicz et al. [14] also reported that the failure occurs near the end of pipe for wall loss defect pipeline and no sign of failure in composite repair in defect section was observed. Many researchers carried out numerical studies and observed the plastic deformation away from defect region when the composite repair

thickness is maintained as per standard ISO/TS24817 [5, 12, 17, 36]. The thicker composite thickness behaves like a rigid body and because of this deformation start to occurs at the steel pipe in non-defected section. It is very important to optimize the repair composite thickness in order to avoid the plastic deformation of steel pipe in non-defected section. This indicates the composite repair thickness calculated based on the design standard is too conservative, which is good for safe repair design but it increases the repair cost as it needs a more composite material.



(a)

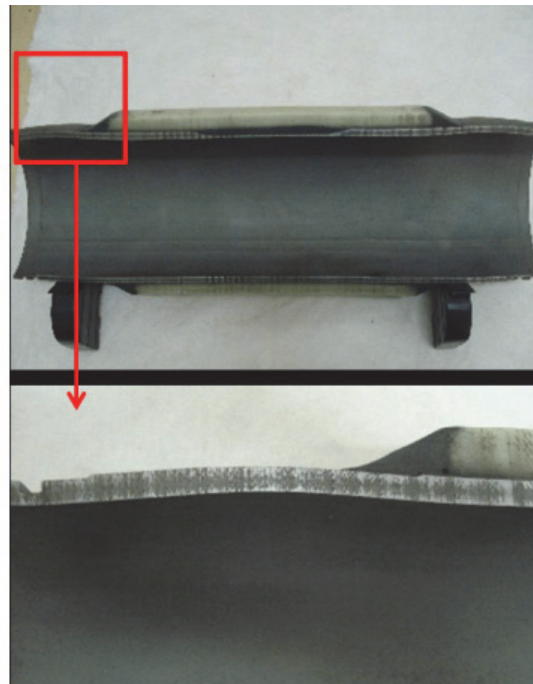

b)

Figure 13: Plastic deformation away from defect region: a) numerical model; b) hydrostatic test [11]

Fig. 14 shows the numerical and analytical failure pressure obtained in all three cases and it clearly shows that the results are closely matches. Pipe extremities condition, plastic behavior are the possible causes for the failure differences between experimental and analytical using ISO/TS24817 standard [37]. However, the failure pressure of repaired pipe obtained analytically (ISO/TS 24817) is lower as compared to the experimental failure pressure, but this will keep more margin and which ultimately safer but with the cost of more composite material and this urge to optimize the composite repair thickness for cost effective repair.

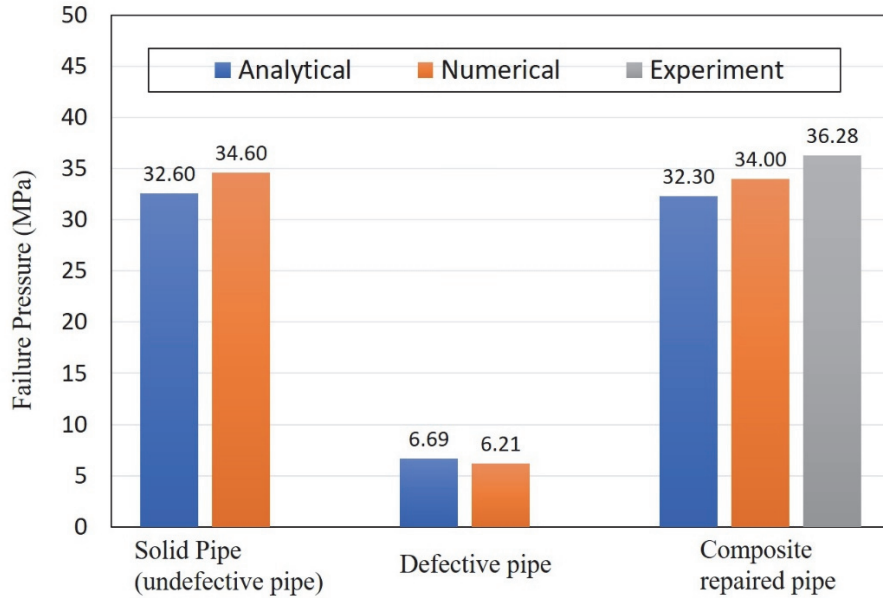

Figure 14: Failure pressure of metallic pipe of three different cases

#### Repaired Pipe Subjected to Maximum Pressure

It is concluded from the last section that the numerical and experimental results of repaired pipe can sustain the designed pressure without any failure sign on the composite repaired section (Fig.13a and b). This implies that repaired pipe can sustain more pressure than the calculated pressure using ISO/TS 24817 standard before failure of repaired pipe. A von Mises failure criterion is used to define the failure in the steel pipe and putty, while Hashin's failure criteria used for composite failure (Eqn. 1, 2 & 3). As a numerical result, the pipe sustained maximum pressure of 46.7 MPa which is 30% higher than the obtained failure pressure as per design standard. Margin of safety is +0.01 (1-0.99) as shown in Fig. 15 with applied pressure of 46.7 MPa. It is found that the observed hoop stress of 252 MPa and axial stress of 41.7 MPa (Fig. 16) which is close to the allowable stress. The higher composite thickness makes composite wrap more stiffer and which lead to plastic deformation in steel pipe as shown in Fig. 17. However, it is not advisable to put maximum pressure as a design pressure for the repaired pipe, as there would chance to fail steel pipe before composite failure in defect section. Therefore, composite thickness should be optimum in such a way that there should not be plastic deformation in pipe and composite wrap should not behave as a rigid body.

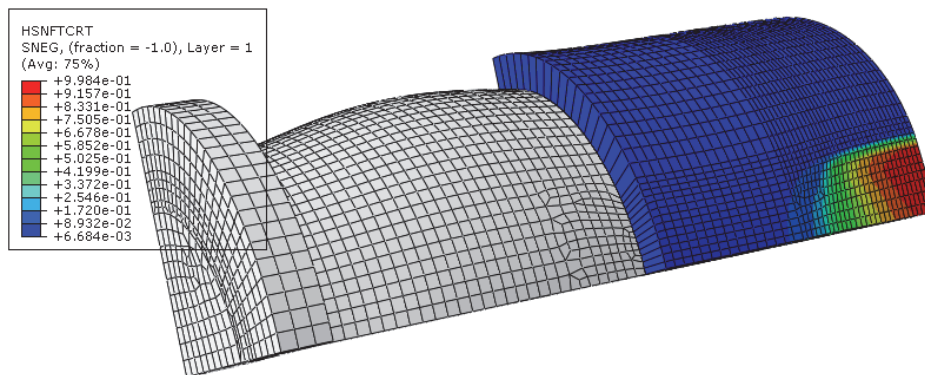

Figure 15: Failure Index by Hashin Failure Criteria with maximum 46.7MPa pressure.

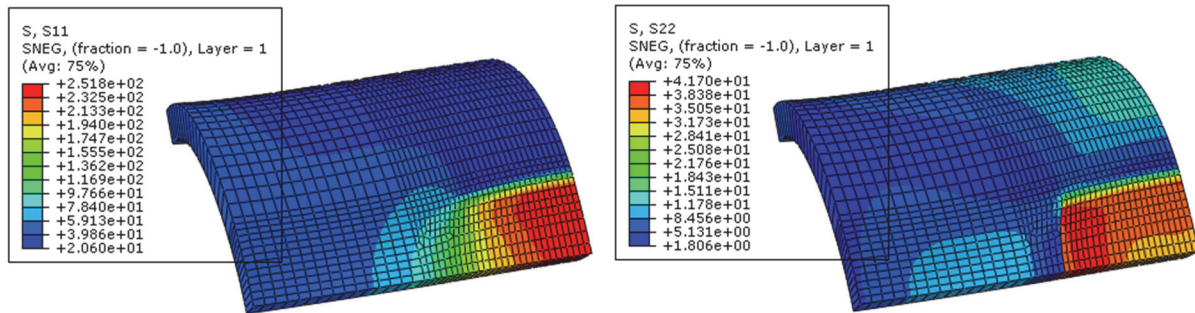

Figure 16: Hoop Stress, 252 MPa and Axial Stress, 41.7 MPa developed on composite wrap.

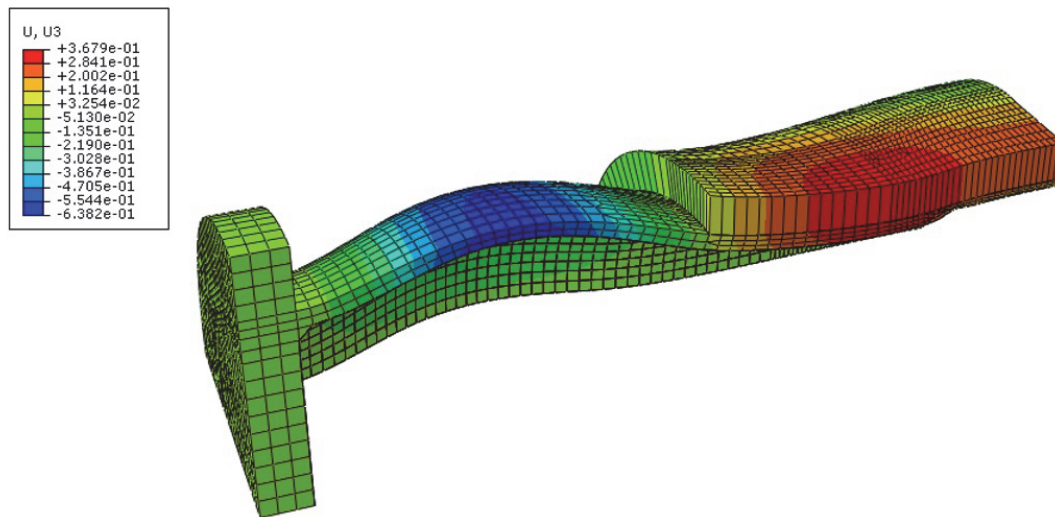

Figure 17: Plastic deformation induced on pipe at maximum failure pressure of 46.7 MPa.

## OPTIMIZATION OF COMPOSITE REPAIR THICKNESS

The thickness of the composite wrap used in the experimental study was 16.2 mm as per ISO/TS 24817 standard and same thickness was kept for numerical analysis. It is clearly observed from hydrostatic test and from numerical analysis, that the failure occurs (plastic deformation) near the close end of pipe. There is no failure in the composite patch which indicates that the provided composite wrap thickness is too conservative. Results also indicate that the composite wrap repair around the defect section of pipe is too strong than the non-defect section of pipe and this possibly due to the high number of composite wrap (composite thickness) and it act as a rigid body. Similar results of over predicting the composite thickness is noticed by other researchers [5, 12, 17] indicating the more conservative nature of repair thickness and there is scope to reduce the composite thickness. In supporting to this, from the numerical analysis of repaired pipe, it proves that the maximum failure pressure (47.5 MPa) that can sustain which is higher than the design pressure by 30 % provided the limiting failure criterion of composite material.

As present composite repair system sustained 1.5 times of design pressure, so scope of composite optimization is relevant. As part of optimization, different thickness has been considered with same weight proportion on longitudinal and lateral direction (the maximum burst pressure for different thickness has been shown in Fig. 18). It can be seen that with an increase in composite repair thickness the sustained internal pressure also increased and it obviously as the more material available to resist. However, there is no point to increase the thickness of composite wrap, as there is cap for upper maximum internal pressure of solid pipe. Therefore, it is very important to optimize the composite repair thickness in terms of economical repair system with keeping design pressure as the upper limit.

Tab. 7 presents the optimized parameters and it was found that the optimal design considered 8.4 mm composite thickness (28 layers) with same weight proportion and sustained 32.3 MPa pressure with 19% (1-0.81) margin as shown in Fig. 19. Observed hoop stress of 236 MPa and axial stress of 38.2 MPa (Fig. 20) and von Mises stress of 372 MPa. Thickness of the



composite wrap used in this study is 16.2 mm as per ISO/TS24817 standard and for the same design pressure the composite thickness found to be 8.4 mm numerically, which is almost double. It implies, that there is possibility to reduce the composite repair cost by reducing the use of composite material for damaged pipe. The same trend was observed in the literature and found almost two- three times difference between the ISO/TS 24817 code and the numerically obtained composite thickness [5, 12, 16-17]. It proves that the code is predicting a very high conservative composite thickness which is good for safety point of view and for long term run and uncertainty can handle if it comes during service period. However, in order to optimize the current repair design philosophy, this conservativeness needs to be gradually reduced based on area of application, which reduce the repair cost and time too. Additionally, the higher composite thickness makes composite wrap more stiffer just like the rigid material which lead to plastic deformation of non-defected section of pipe for higher design pressure.

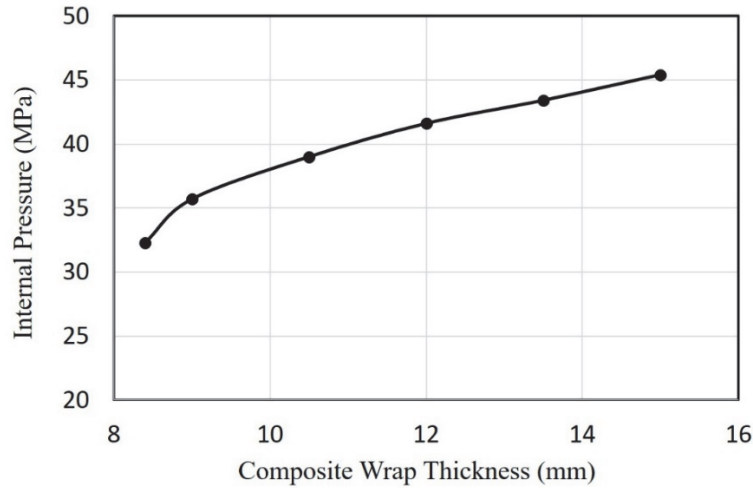

Figure 18: Internal pressure for composite wrap thickness

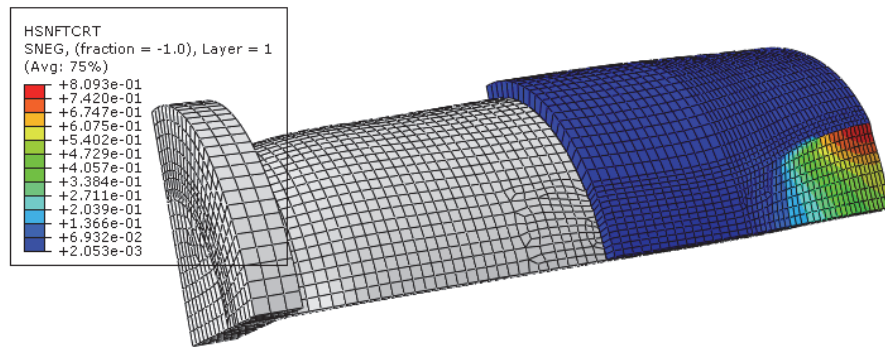

Figure 19: Failure Index by Hashin Failure Criteria with 32.3 MPa pressure.

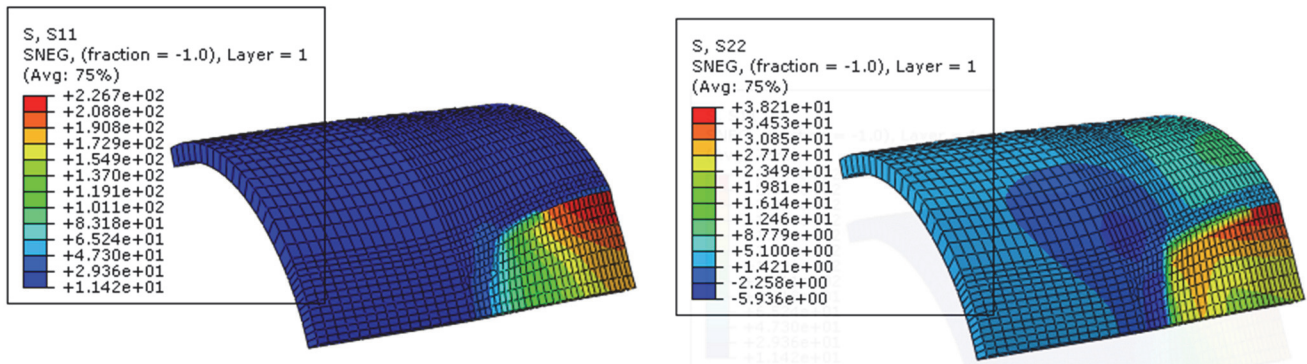

Figure 20: Hoop Stress, 227 MPa and Axial Stress, 38.2 MPa developed on composite wrap.



Sr. No.	No of Layers	Thickness (mm)	Pressure (MPa)	Hoop Stress (MPa)	Axial Stress (MPa)	Failure Indices	MoS
1	50	15.0	45.4	252	40.7	0.99	0.01
2	45	13.5	43.4	251	39.7	0.99	0.01
3	40	12.0	41.6	251	39.0	0.99	0.01
4	35	10.5	39.0	250	39.2	0.99	0.01
5	30	9.0	35.7	251	40	0.99	0.01
6	28	8.4	32.3	227	38.2	0.81	0.19

Table 7: Optimized design parameters of wall loss defect pipelines for different composite repair thickness

## CONCLUSIONS

In this research paper a numerical analysis is carried out on repaired pipe with wall loss defect and other several cases which includes: pipe without defect, pipe with wall loss defect and the numerical results were validated with experimental results. In addition to that optimization of composite repair thickness is also carried out. Based on the results following observations and conclusions are drawn:

- The numerical results for both non-defective and defective (80% wall loss) pipe are in good agreement with the analytical results.
- FEA results of repaired pipe revealed that failure pressure based on ISO/TS 24817 design code is too conservative. For the given test, numerical results observe the failure behavior (plastic deformation) and failure location (away from defect region), which closely resemblance with the hydrostatic test results.
- The wall loss defect repaired pipeline is sustained the design pressure of 32.3 MPa pressure, having 16.1 mm composite repair thickness as per standard ISO/TS 24817. However, numerical results reveal that with the same repair thickness, the repaired pipe can sustain the maximum failure pressure of 47.5 MPa which is 30% higher than the design pressure and this proves the need of optimization of composite thickness for more economical repair system.
- From the optimization results it is found that 8.4 mm composite repair thickness can sustain the design pressure of 32.3 MPa rather than going for 16.1 mm composite thickness, which is obtained from standard code ISO/TS 24817. Thus, the optimization process of composite repair thickness can be started using numerically and need to be validated using a large experimental test plan.
- Possible future scope on this work would include design of new composite wrap geometry in terms of their dimensions, thickness and the orientation of layers, etc. for cost effective repair system.
- Further investigations are required to provide an accurate and effective composite repair thickness of repair system by accounting interface bonding and filler material properties in the numerical analysis and same should be validate with experimental results.

## ACKNOWLEDGEMENTS

The authors would like to acknowledge the Computational Mechanics Lab, NIT Calicut and support of the Brazilian research agencies CNPQ, CAPES and FAPERJ.

## REFERENCES

- [1] Francis, R. (1984). Galvanic corrosion of high alloy stainless steel in sea water, *Br Corros J.*, 29(1), pp. 53-57.



- [2] ISO 24817 (2006). Petroleum, Petrochemical and Natural Gas Industries-Composite Repairs for Pipework-Qualification and Design, Installation, Testing and Inspection. International Standard Organization.
- [3] ASME PCC-2 (2011). Repair of Pressure Equipment and Piping, The American Society of Mechanical Engineers, New York.
- [4] Rohem, N.R.F., Pacheco, L.J., Budhe, S., Banea, M.D., Sampaio, E.M. and de Barros, S. (2016). Development and qualification of a new polymeric matrix laminated composite for pipe repair, *Compos. Struct.*, 152, pp. 737–745.
- [5] Duell, J.M., Wilson, J.M. and Kessler, M.R. (2008). Analysis of a carbon composite over wrap pipeline repair system, *Int J Pres Ves Pip.*, 85, pp. 782-788.
- [6] da Costa Mattos, H.S., Reis, J.M.L., Paim, L.M., da Silva, M.L., Lopes Junior, R. and Perrut V.A. (2014). Analysis of a glass fibre reinforced polyurethane composite repair system for corroded pipelines at elevated temperatures, *Compos. Struct.*, 114, pp. 117-123.
- [7] Budhe, S., Banea, M.D., de Barros, S. and Rohem, N.R.F. (2018). Assessment of failure pressure of a GFRP composite repair system for wall loss defect in metallic pipelines, *Material Science and Engineering Technology (Materialwissenschaft und Werkstofftechnik)*, 49(7), pp. 902-911, 2018. DOI 10.1002/mawe.201700055.
- [8] de Barros, S., Budhe, S., Banea, M.D., Rohem, N.R.F., Sampaio, E.M., Perrut, V.A. and Lana, L.D.M. (2018). An assessment of composite repair system in offshore platform for corroded circumferential welds in super duplex steel pipe, *Frattura ed Integrità Strutturale (Fracture and Structural Integrity)*, 44, pp. 151-160. DOI: 10.3221/IGF-ESIS.44.12.
- [9] da Costa Mattos, H.S., Paim, L.M. and Reis, J.M.L. (2012). Analysis of burst tests and long-term hydrostatic tests in produced water pipelines, *Eng. Fail. Anal.*, 22, pp. 128-140.
- [10] da Costa Mattos, H.S., Reis, J.M.L. Sampaio, R.F. and Perrut, V.A. (2009). An alternative methodology to repair localized corrosion damage in metallic pipelines with epoxy resins, *Mater Des.*, 30, pp 3581–3591.
- [11] Budhe, S., Banea, M.D., Rohem, N.R.F., Sampaio, E.M. and S. de Barros, S. (2017). Failure pressure analysis of composite repair system for wall loss defect of metallic pipelines, *Compos. Struct.*, 176, pp. 1013-1019.
- [12] Saeed, N., Ronagh, H. and Virk A. (2014). Composite repair of pipelines, considering the effect of live pressure-analytical and numerical models with respect to ISO/TS 24817 and ASME PCC-2, *Compos Part B-Eng.*, 58, 2014, pp. 605–610.
- [13] Freire, J.L.F., Vieira, R.D., Diniz, J.L.C. and Meniconi, L.C. (2007). Applications of experimental techniques in the field of pipeline integrity series - part 7: effectiveness of composite repairs applied to damaged pipeline, *Exp Tech*, 31, pp. 59–66.
- [14] Budhe, S., M. D. Banea, M.D. and de Barros, S. (2020). Composite repair system for corroded metallic pipelines: an overview of recent developments and modelling, *Journal of Marine Science and Technology*, 25, pp. 1308–1323. DOI: 10.1007/s00773-019-00696-3.
- [15] Budhe, S., M. D. Banea, M.D. and S. de Barros. (2020). Prediction of the burst pressure for defective pipelines using different semi-empirical models, *Frattura ed Integrità Strutturale*, 52, pp. 137-147. DOI: 10.3221/IGF-ESIS.52.12.
- [16] Lim, K.S., Azraai, S.N.A., Yahaya, N. (2019). Behaviour of steel pipelines with composite repairs analysed using experimental and numerical approaches, *Thin Wall Structure*, 139, pp. 321-333.
- [17] Mazurkiewicz, L., Tomaszewski, M., Malachowski, J., Sybilski, K., Chebakov, M., Witek, M., Yukhymets, P. and Dmitrienko, R. (2017). Experimental and numerical study of steel pipe with part-wall defect reinforced with fibre glass, *Int. J. Press. Ves. Pip.*, 149, pp. 108-119.
- [18] Chen, J., H. Wang, H., Salemi, M. and Balaguru. P.N. (2021). Finite Element Analysis of Composite Repair for Damaged Steel Pipeline. *Coatings*, 11(3) pp. 301. DOI: 10.3390/coatings11030301.
- [19] D. Djahida, D., Tewfik, G., Witek, M. and Abdelghani, M. (2021). Analytical Model and Numerical Analysis of Composite Wrap System Applied to Steel Pipeline, *Materials.*, 14(21), pp. 6393. DOI: 10.3390/ma14216393.
- [20] Keller, M.W., B.D. Jellison, B.D. and Ellison, T. (2013). Moisture effects on the thermal and creep performance of carbon fiber/epoxy composites for structural pipeline repair, *Compos Part B: Eng.*, 45(1), pp. 1173–1180.
- [21] Shouman, A., Taheri, F. (2011) Compressive strain limits of composite repaired pipelines under combined loading states, *Compos. Struct.*, 93, pp. 1538–1548.
- [22] Chan, P.H., Tshai, K.Y., Johnson, M., Choo, H.L., Li, S. and Zakaria, K. (2015). Burst strength of carbon fibre reinforced polyethylene strip pipeline repair system – a numerical and experimental approach, *J. Compos. Mater.*, 49, pp. 749–756.
- [23] Shamsuddoha, M., Islam, M.M., Aravinthan, T., Manalo, A. and Lau, K.T. (2013). Characterization of mechanical and thermal properties of epoxy grouts for composite repair of steel pipelines, *Mater. Des.*, 52, pp. 315–327.



- [24] Mahdi, E. and Eltai, E. (2018). Development of cost-effective composite repair system for oil/gas pipelines, *Compos. Struct.*, 202, pp. 802-806.
- [25] Shamsuddoha, M., Manalo, A., Aravinthan, T., Islam, M. and Djukic, L. (2021). Failure analysis and design of grouted fibre-composite repair system for corroded steel pipes. *Eng. Fail. Anal.*, 119, 104979.
- [26] Muda, M.F., Hashim, M.H.M., Kamarudin, M.K., Mohd, M.H., Tafsirojjaman, T., Rahman, M.A. and Paik, J.K. (2022). Burst pressure strength of corroded subsea pipelines repaired with composite fiber-reinforced polymer patches. *Eng. Fail. Anal.*, 136, 106204.
- [27] Arifin, H.H., Zardasti, L., Lim, K. S., Noor, N. Md., Yahaya, Mazlan, A.N. and Mohd, R. (2021). Stress distribution analysis of composite repair with Carbon Nanotubes reinforced putty for damaged steel pipeline. *Int. J. Pres. Ves. Pip.*, 194, Part A, 104537.
- [28] Singh, D.K., Villamayor, A., and Hazra, A. (2021). Numerical and experimental analysis of loctite adhesive composite wrapping on EN 10028 steel pipe. *Materials Today: Proceedings*, 44(6), pp. 4158-4165.
- [29] Alexander, C., Vyvial, B. and Wilson, F. (2014). Pipeline repair of corrosion and dents: a comparison of composite repairs and steel sleeves, In: 10th International pipeline conference, Alberta.
- [30] Budhe, S., Banea, M.D. and de Barros, S. (2020). Analysis of Failure Pressure of Defective Pipes Repaired with Composite Systems Considering the Plastic Deformation of Pipe, *Journal of the Institution of Engineers (India) Series C*, 101, pp. 929-936.
- [31] Alexander, C. (2007). Development of composite repair system for reinforcing offshore risers. Texas A&M University, Texas.
- [32] Zecheru, G., Dumitrescu, A. and Dinita, A. (2018). Design of composite repair systems. In: Barkanov, E.N., Dumitrescu, A. and I.A. Parinov (eds) *Non-destructive testing and repair of pipelines*. Springer, Cham, pp. 269-285.
- [33] Shouman, A. and Taheri, F. (2011). Compressive strain limits of composite repaired pipelines under combined loading states, *Compos. Struct.*, 93(6), pp. 1538-1548.
- [34] Theisen, S.A. and Keller, M.W. (2017). Comparison of Patch and Fully Encircled Bonded Composite Repair, In *Mechanics of Composite and Multi-Functional Materials; Society for Experimental Mechanics Series*; Springer International Publishing: Berlin/Heidelberg, Germany, 35, pp. 101-106.
- [35] Ayaz, Y., Çitil, S. and Sahan, M.F. (2016). Repair of small damages in steel pipes with composite patches, *Mater. Werkst.*, 47, pp. 503-511.
- [36] Alexander, C.R. (2009). Development of standards for composite repair systems, *Pipeline & Gas Technology Magazine LP*, Hart Energy Publishing.
- [37] Budhe, S., Banea, M.D. and de Barros, S. (2019). Prediction of Failure Pressure for Defective Pipelines Reinforced with Composite System, Accounting for Pipe Extremities, *J Fail. Anal. And Preven.*, 19, pp. 1832-1843.